

## EMMU 40

Locknut, brass nickel-plated, M40

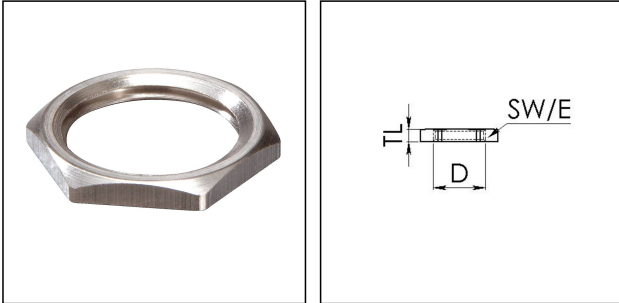

Products may differ in size, colour and appearance to those shown. If you require further information or customisation, please contact us directly.



<b>Material</b>	Brass nickel-plated
<b>Surface</b>	Nickel-plated
<b>Temp. range min</b>	-200 °C
<b>Temp. range max</b>	250 °C
<b>Thread type</b>	M
<b>Ø Connection thread D</b>	40
<b>Lead</b>	1,5
<b>Key width SW</b>	46 mm
<b>Collar diameter (E)</b>	50 mm
<b>Total length TL</b>	5 mm
<b>Order no. nickel-plated</b>	10063146
<b>Type</b>	EMMU 40
<b>Packing unit</b>	50
<b>EAN number</b>	4007685631464
<b>Tariff number</b>	74153300
<b>ETIM-Classification</b>	EC000940

27.03.2024

Your Contact:

**WISKA Hoppmann GmbH**

Kisdorfer Weg 28 · 24568 Kaltenkirchen · Germany

☎ +49-4191-508-0 · 📠 +49-4191-508-209

contact@wiska.de · www.wiska.com



Your Contact:

**WISKA Hoppmann GmbH**

Kisdorfer Weg 28 · 24568 Kaltenkirchen · Germany

☎ +49-4191-508-0 · 📠 +49-4191-508-209

contact@wiska.de · www.wiska.com